



Parameter	Ratings	Units
Blocking Voltage	350	V _P
Load Current	120	mA
Max R _{ON}	35	Ω

Features

- 100% Solid State
- Low Drive Power Requirements (TTL/CMOS Compatible)
- Arc-Free With No Snubbing Circuits
- 3750V_{rms} Input/Output Isolation
- FCC Compatible
- VDE Compatible
- No EMI/RFI Generation
- Machine Insertable, Wave Solderable

Applications

- Telecommunications
 - Telecom Switching
 - Tip/Ring Circuits
 - Modem Switching (Laptop, Notebook, Pocket Size)
 - Hook Switch
 - Dial Pulsing
 - Ground Start
 - Ringing Injection
- Instrumentation
 - Multiplexers
 - Data Acquisition
 - Electronic Switching
 - I/O Subsystems
 - Meters (Watt-Hour, Water, Gas)
- Medical Equipment-Patient/Equipment Isolation
- Security
- Aerospace
- Industrial Controls

Description

LBA110 is 350V, 120mA, 35Ω independent 1-Form-A and 1-Form-B relays. It is designed to provide an ideal solution where a complimentary Form-A/Form-B relay pair is required.

Approvals

- UL Recognized: File Number E76270
- CSA Certified: File Number LR 43639-10
- EN/IEC 60950-1:2001 Compliant

Ordering Information

Part #	Description
LBA110	8-Pin DIP (50/Tube)
LBA110S	8-Pin Surface Mount (50/Tube)
LBA110STR	8-Pin Surface Mount (1,000/Reel)
LBA110P	8-Pin Flat Pack (50/Tube)
LBA110PTR	8-Pin Flat Pack (1,000/Reel)

Pin Configuration

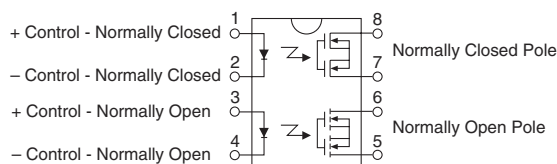

Switching Characteristics of Normally Open (Form A) Devices

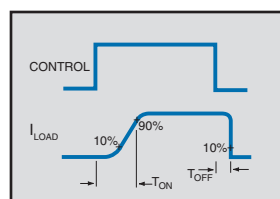

Switching Characteristics of Normally Closed (Form B) Devices

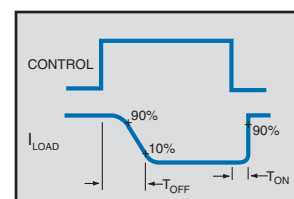

Absolute Maximum Ratings

Parameter	Ratings	Units
Blocking Voltage	350	V_P
Reverse Input Voltage	5	V
Input Control Current	50	mA
Peak (10ms)	1	A
Input Power Dissipation ¹	150	mW
Total Power Dissipation ²	800	mW
Isolation Voltage, Input to Output	3750	V_{rms}
Operational Temperature	-40 to +85	°C
Storage Temperature	-40 to +125	°C

¹ Derate Linearly 1.33 mW/°C

² Derate Linearly 6.67 mW/°C

Electrical absolute maximum ratings are at 25°C

Absolute Maximum Ratings are stress ratings. Stresses in excess of these ratings can cause permanent damage to the device. Functional operation of the device at conditions beyond those indicated in the operational sections of this data sheet is not implied.

Electrical Characteristics

Parameter	Conditions	Symbol	Min	Typ	Max	Units
Output Characteristics @ 25°C						
Load Current, Continuous ¹	-	I_L	-	-	120	mA
Peak Load Current	t = 10ms	I_{LPK}	-	-	350	mA
On-resistance	$I_L=120mA$	R_{ON}	-	25	35	Ω
Off-State Leakage Current	$V_L=350V$	I_{LEAK}	-	-	1	μA
Switching Speeds						
Turn-On	$I_F=5mA, V_L=10V$	T_{ON}	-	-	3	ms
Turn-Off	$I_F=5mA, V_L=10V$	T_{OFF}	-	-	3	ms
Output Capacitance	50V; f=1MHz	C_{OUT}	-	25	-	pF
Input Characteristics @ 25°C						
Input Control Current	$I_L=120mA$	I_F	-	-	2	mA
Input Dropout Current	-	I_F	0.4	0.7	-	mA
Input Voltage Drop	$I_F=5mA$	V_F	0.9	1.2	1.4	V
Reverse Input Current	$V_R=5V$	I_R	-	-	10	μA
Common Characteristics @ 25°C						
Input to Output Capacitance	-	$C_{I/O}$	-	3	-	pF

¹ If both poles operate the load current must be derated so as not to exceed the package power dissipation value.

PERFORMANCE DATA*

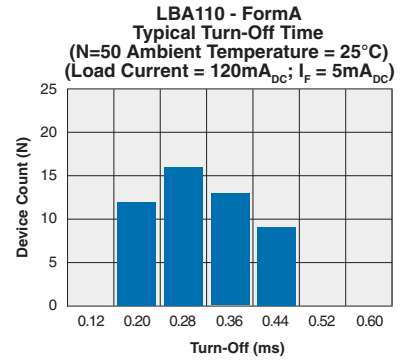
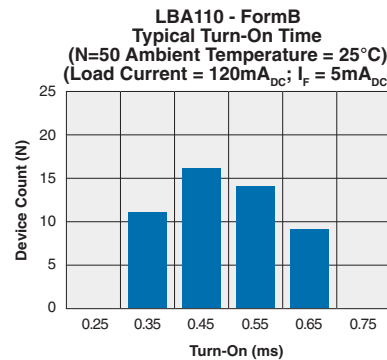
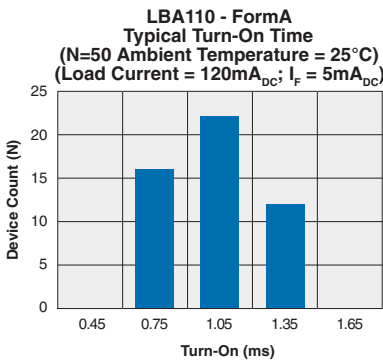
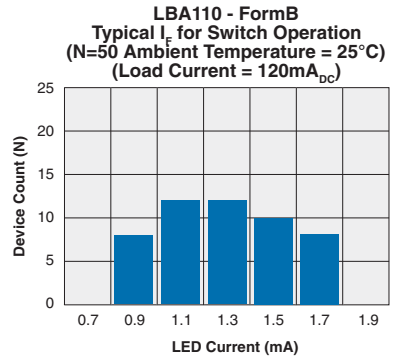
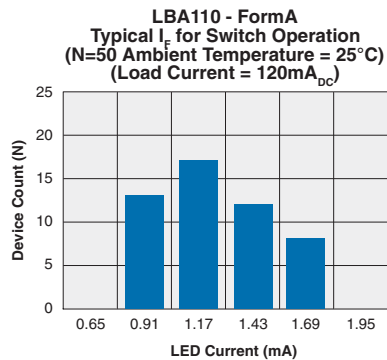
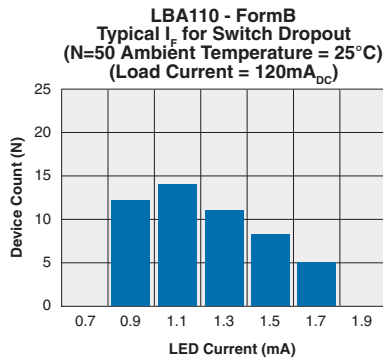
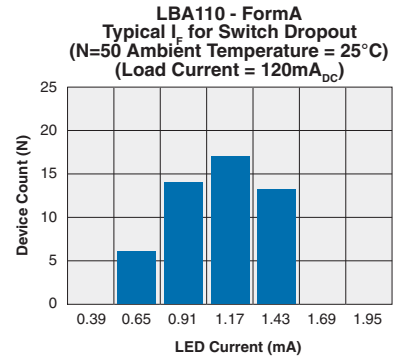
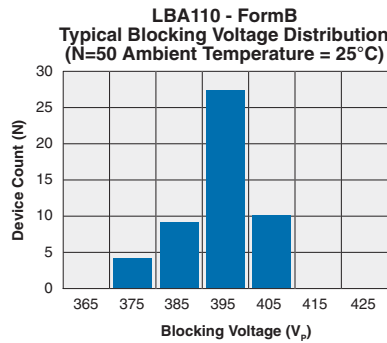
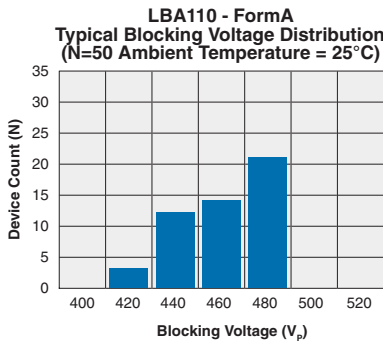
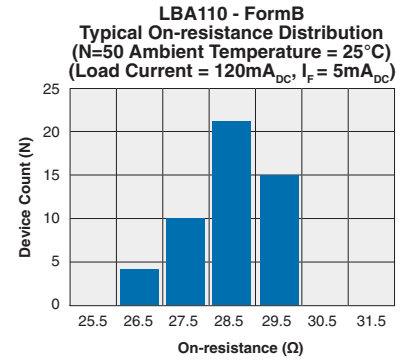
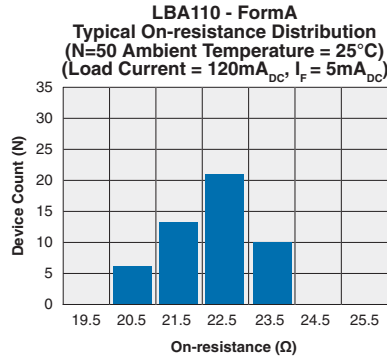
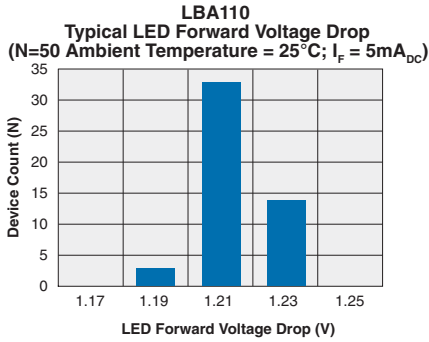

*The Performance data shown in the graphs above is typical of device performance. For guaranteed parameters not indicated in the written specifications, please contact our application department.

PERFORMANCE DATA*

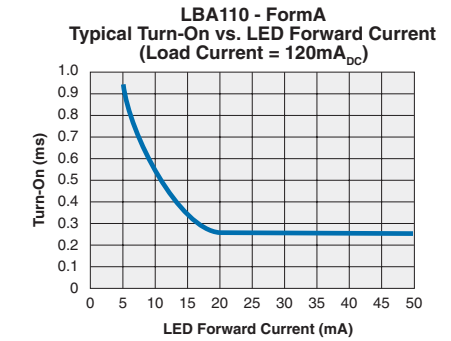
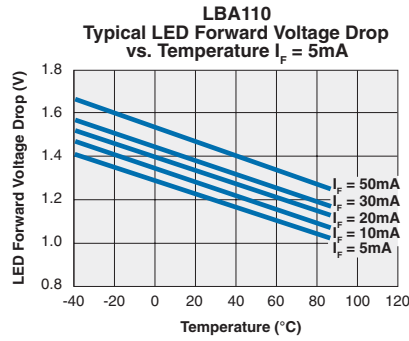
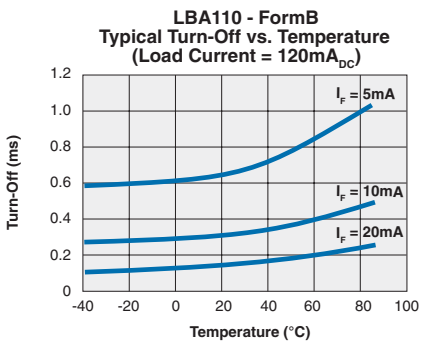
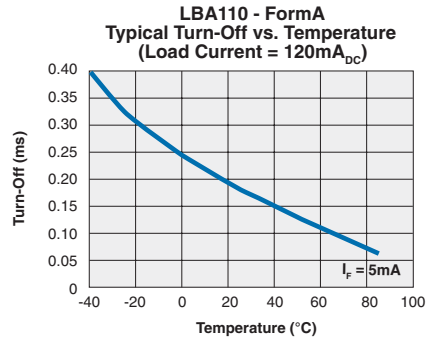
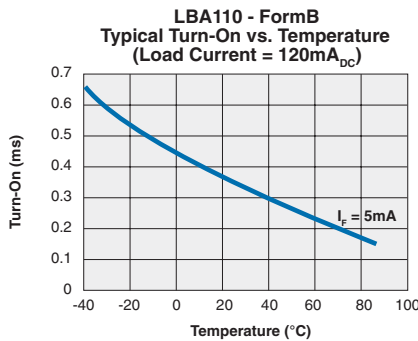
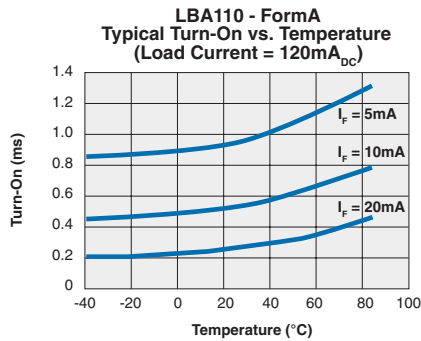
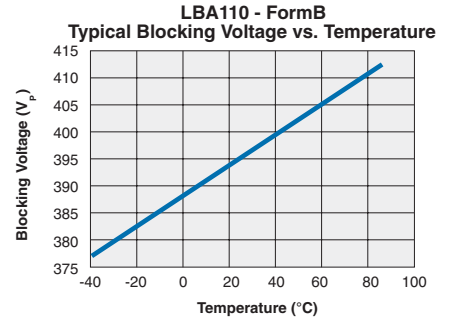
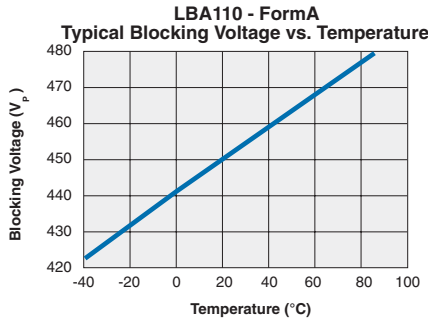
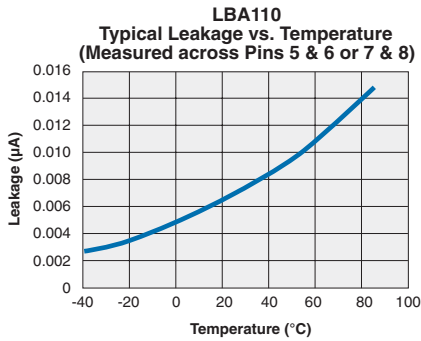
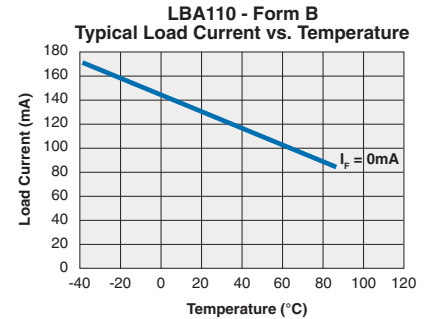
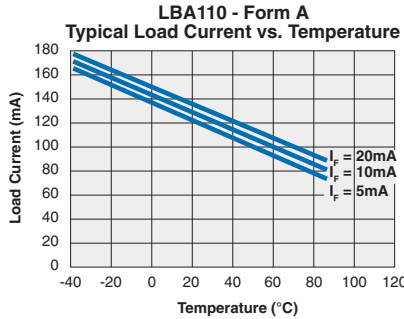
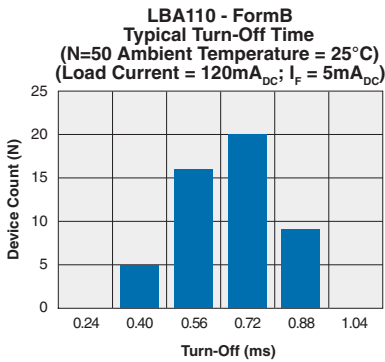

*The Performance data shown in the graphs above is typical of device performance. For guaranteed parameters not indicated in the written specifications, please contact our application department.

PERFORMANCE DATA*

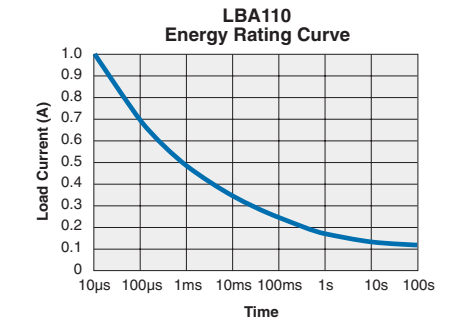
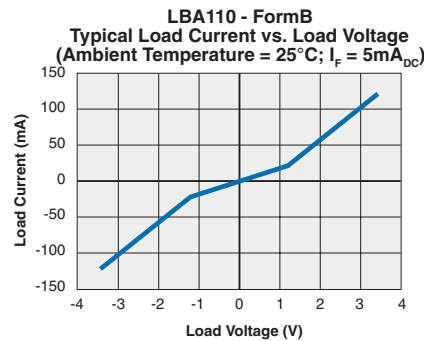
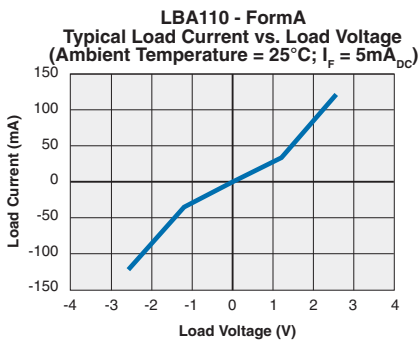
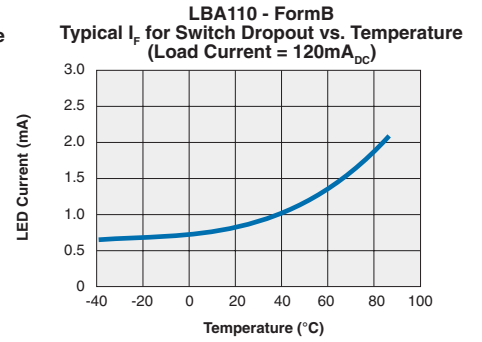
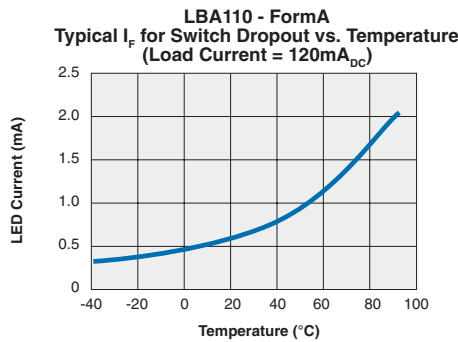
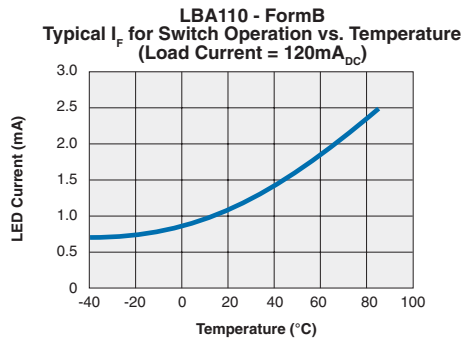
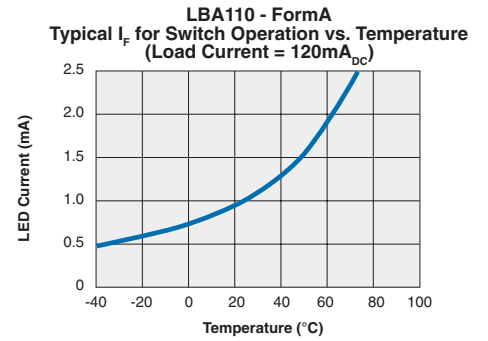
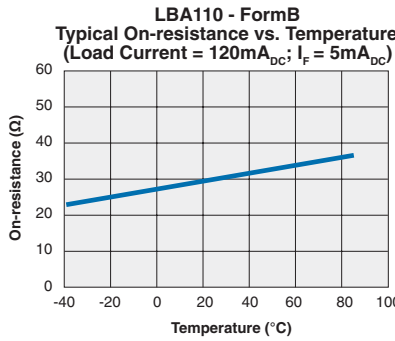
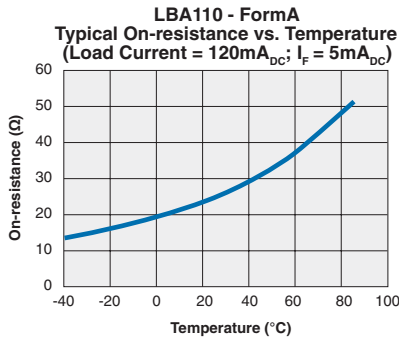
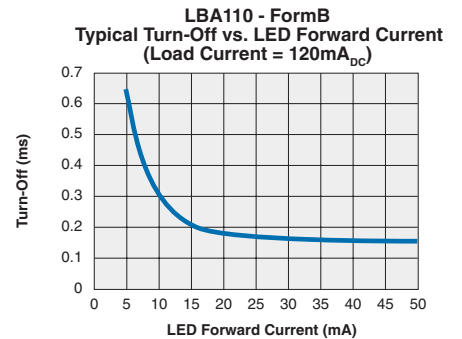
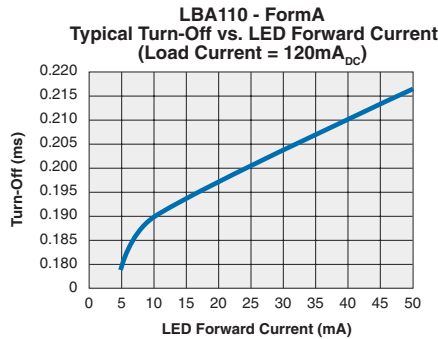
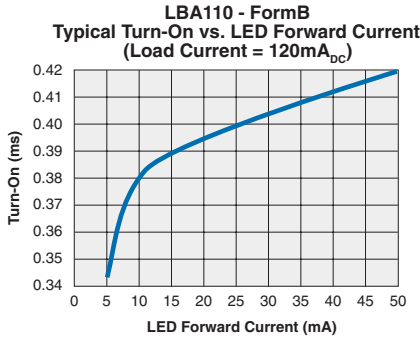

*The Performance data shown in the graphs above is typical of device performance. For guaranteed parameters not indicated in the written specifications, please contact our application department.

Manufacturing Information

Soldering

For proper assembly, the component must be processed in accordance with the current revision of IPC/JEDEC standard J-STD-020. Failure to follow the recommended guidelines may cause permanent damage to the device resulting in impaired performance and/or a reduced lifetime expectancy.

Recommended soldering processes are limited to 260°C component body temperature for 10 seconds.

Washing

Clare does not recommend ultrasonic cleaning or the use of chlorinated solvents.



MECHANICAL DIMENSIONS

8-Pin DIP Through Hole (Standard)

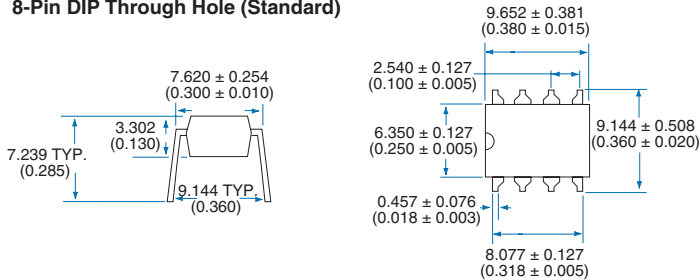

PC Board Pattern (Top View)

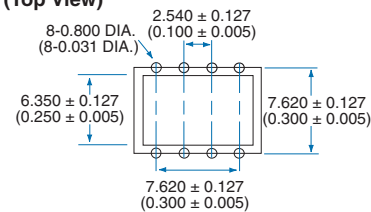

8-Pin Surface Mount ("S" Suffix)

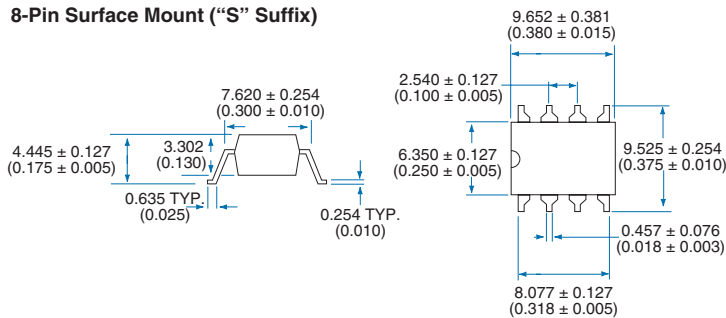

PC Board Pattern (Top View)

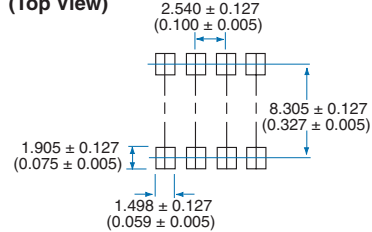

8-Pin Flatpack ("P" Suffix)

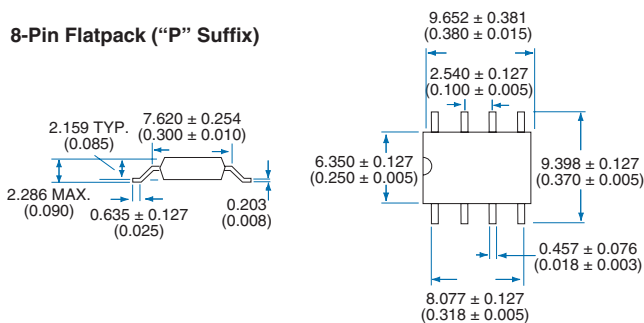

PC Board Pattern (Top View)

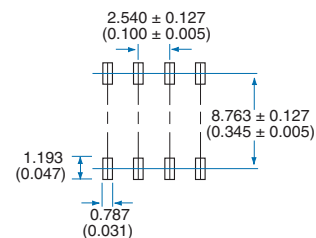

Dimensions
mm
(inches)

MECHANICAL DIMENSIONS

Tape and Reel Packaging for 8-Pin Surface Mount Package

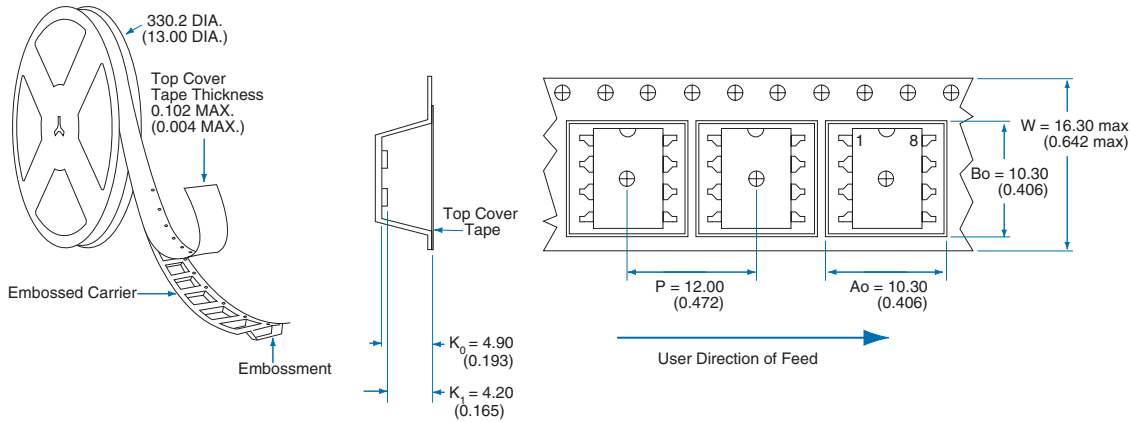

NOTE: Tape dimensions not shown, comply with JEDEC Standard EIA-481-2

Tape and Reel Packaging for 8-Pin Flatpack Package

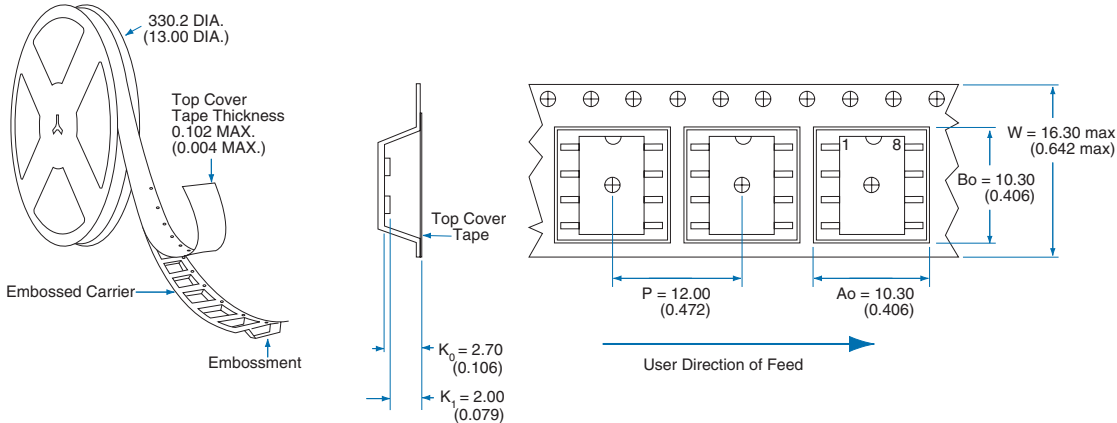

NOTE: Tape dimensions not shown, comply with JEDEC Standard EIA-481-2

Dimensions
mm
(inches)

For additional information please visit our website at: www.clare.com

Clare, Inc. makes no representations or warranties with respect to the accuracy or completeness of the contents of this publication and reserves the right to make changes to specifications and product descriptions at any time without notice. Neither circuit patent licenses nor indemnity are expressed or implied. Except as set forth in Clare's Standard Terms and Conditions of Sale, Clare, Inc. assumes no liability whatsoever, and disclaims any express or implied warranty, relating to its products including, but not limited to, the implied warranty of merchantability, fitness for a particular purpose, or infringement of any intellectual property right.

The products described in this document are not designed, intended, authorized or warranted for use as components in systems intended for surgical implant into the body, or in other applications intended to support or sustain life, or where malfunction of Clare's product may result in direct physical harm, injury, or death to a person or severe property or environmental damage. Clare, Inc. reserves the right to discontinue or make changes to its products at any time without notice.

Specification: DS-LBA110-R07
©Copyright 2006, Clare, Inc.
OptoMOS® is a registered trademark of Clare, Inc.
All rights reserved. Printed in USA.
10/27/06